

ORDERING PARTS

FAST & EASY!

LOWEST PRICE!

1) Seek Part(s) from your models illustrated diagram, cross over REF# to PART#

2) Type PART# into sites [Search Box] at GoKartsRus.com TIP! - RIGHT CLICK LINK, SELECT OPEN IN NEW TAB

3) Add all needed parts to Shopping Cart | Complete "Checkout" | ✓ Done!

If a part does not come up in a Site Search, please [Contact Us](#) (include part# in email)

Bushing Service Instructions

12884 Clutch – 41-10T

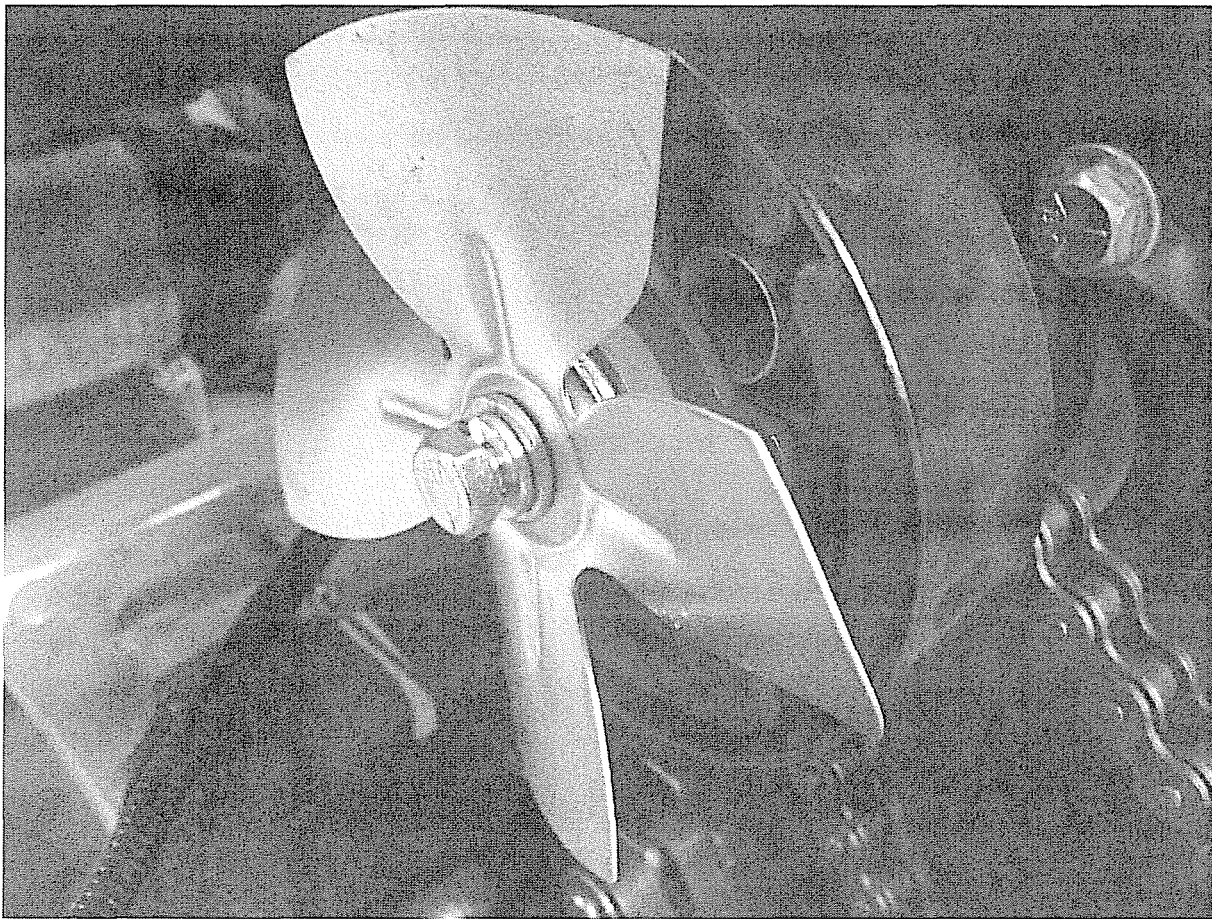

Required Tools:

- (1) Ratchet or Air Hammer
- (1) 3/8 inch nut driver
- (1) 1/2 inch socket
- (1) Hammer
- (1) Pair of Needle Nose Pliers
- (1) Soft Abrasive Pad or Cleaner
- (4) Drops of 30 Weight Oil

Removing the Plastic Cover:

1. Remove (5) five bolts that fasten the cover to the Engine Guard, using the 3/8 inch nut driver.
2. Set bolts and cover aside for re-installation.

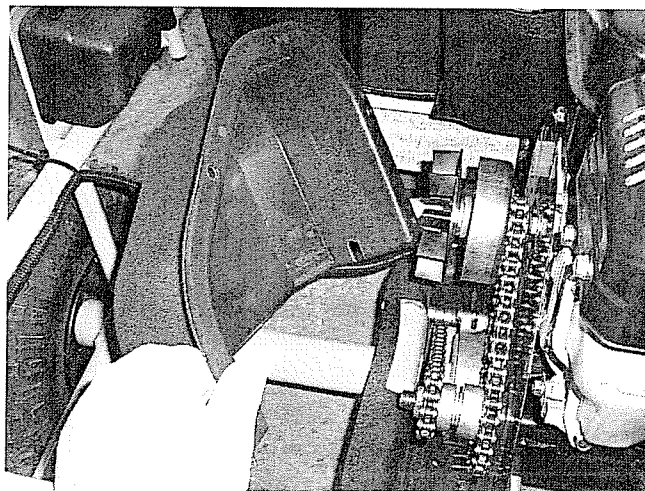
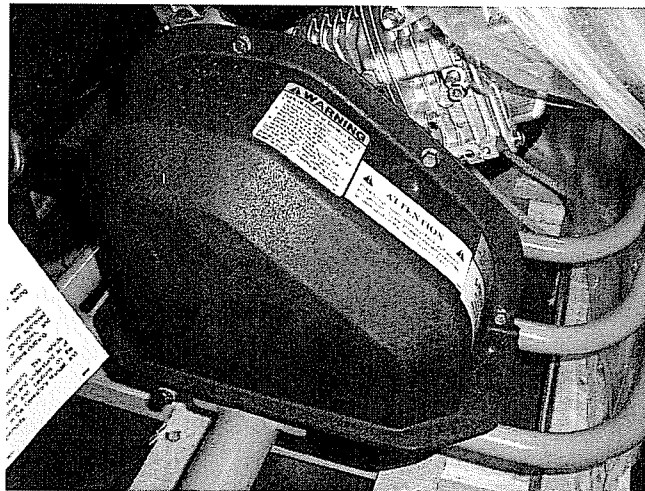

Loosening the Chain:

1. Using a ½ inch wrench, loosen the (4) nuts that hold the engine mount bolts in place on the bottom of the frame. **DO NOT REMOVE BOLTS.**
2. Slide the Engine towards the jackshaft (rear of kart) and the jackshaft towards the engine (front of kart). Both Chains will become loose.

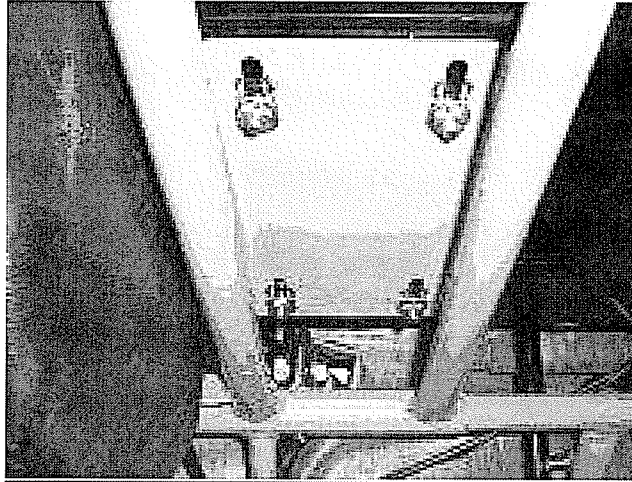

Removing the Chain:

3. Use the needle-nose pliers to remove the master link/ clip and then remove the chain from the sprocket.
4. Set Chain & Master Link/ Clip aside for re-installation

Remove inner chain **ONLY**

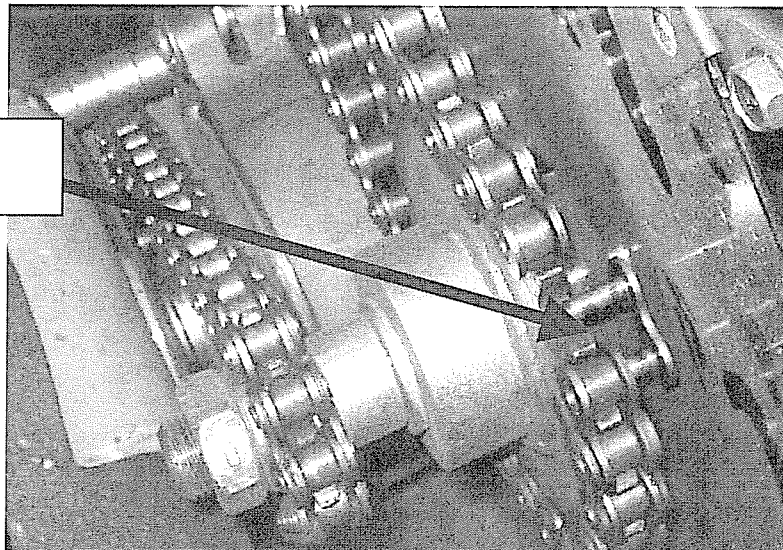

Removing the Clutch Retaining Bolt:

1. Use the ½ inch socket to turn the bolt until the engine is at its highest compression point (Top Dead Center).
2. Use a hammer to tap on the end of the ratchet, breaking the bolt free from the shaft.
3. Loosen the bolt normally and remove from shaft.
4. Set bolt aside for re-installation

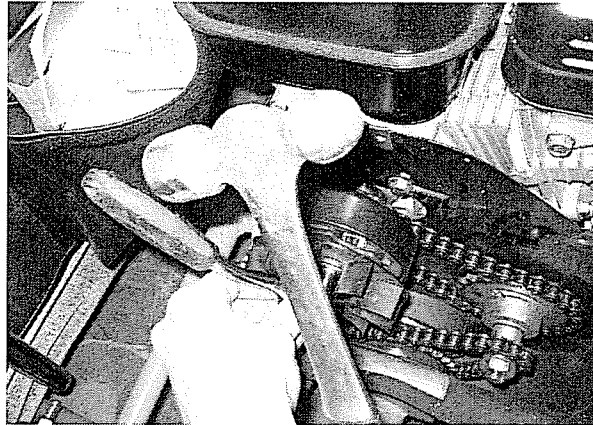

Removing the Fan & Clutch:

1. After removing the retaining bolt, continue to remove washers, fan & clutch as illustrated below.
2. Set aside bolt, washers & fan for re-installation purposes.

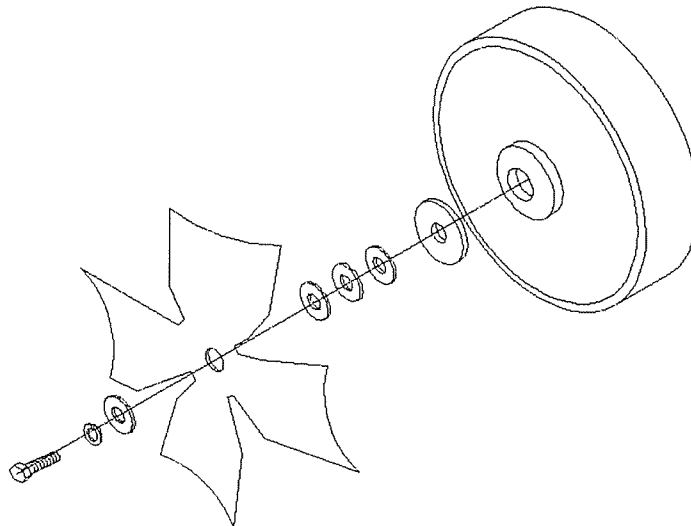

Disassembling the Clutch:

1. Remove the shoe & spring sub-assembly
2. Remove the bushing
3. Set aside shoe & spring sub-assembly and clutch housing for re-installation purposes.

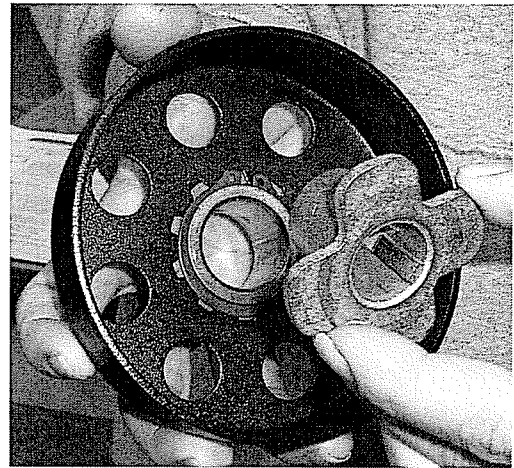
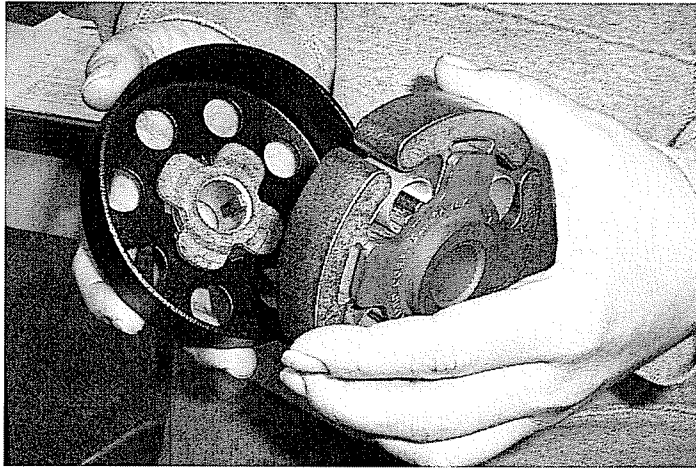

Evaluation of Bushing:

1. Inspect the bushing to see if it has a residue build-up.
2. Inspect the bushing for cracks or a failed keyway.
3. If cracks or failed keyway are present, call Manco PowerSports for replacement bushing.

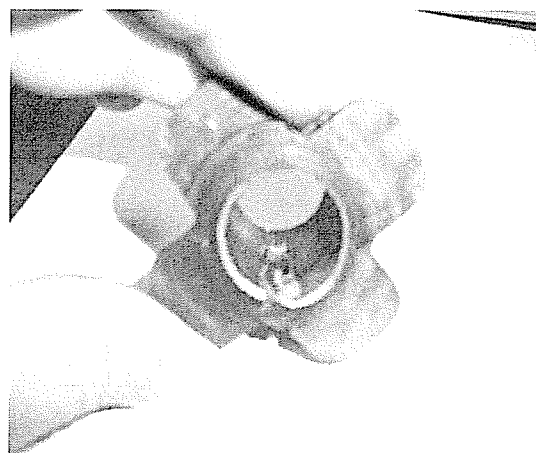
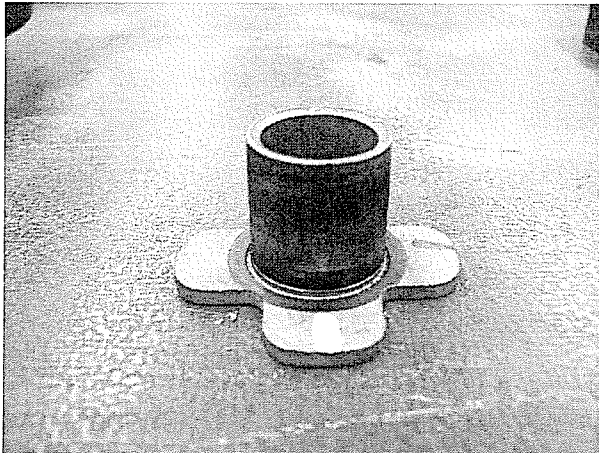

Cleaning of Bushing:

1. Once bushing is determined to be structurally sound, it should be thoroughly cleaned
2. Clean the outer surface of the bushing using a soft abrasive pad or cloth until bushing appears to have renewed luster. **DO NOT USE SOLVENTS OR CHEMICAL CLEANERS.** Chemicals may breakdown the impregnated oils in the bushing.
3. Once surface is clean and luster is renewed, place (3) to (4) drops of 30 weight oil on bushing and wipe around the outer surface of the bushing until evenly coated.

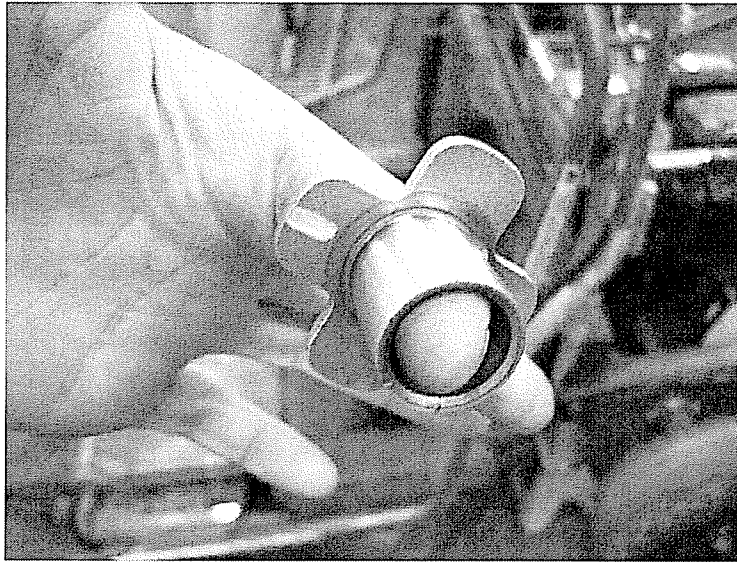

Re-assembling the Clutch:

1. Insert Bushing into Clutch Housing
2. Insert shoe & spring sub-assembly into clutch housing.
3. Ensure bushing and shoe & spring sub-assembly keyways are aligned

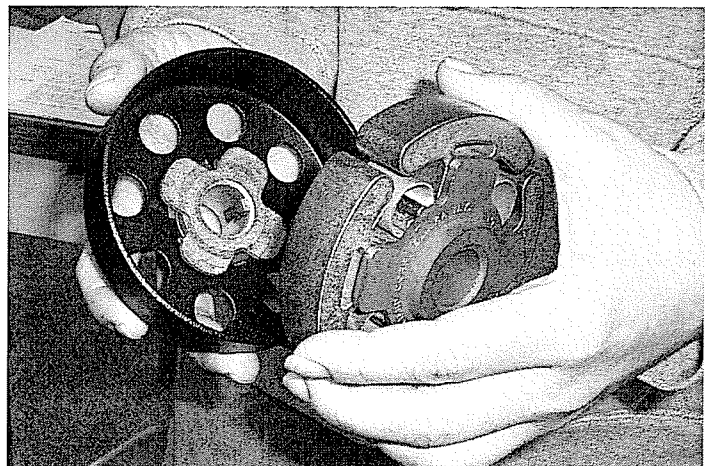
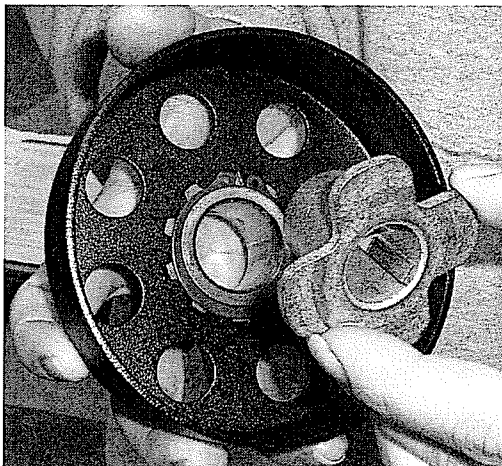

Re-assembling the Fan & Clutch:

1. On the shaft, re-install clutch, washers & fan as illustrated below.
2. Ensure Convex Ridges point towards the engine (refer to photo on front cover).
3. Place bolt on the end of shaft as illustrated below.

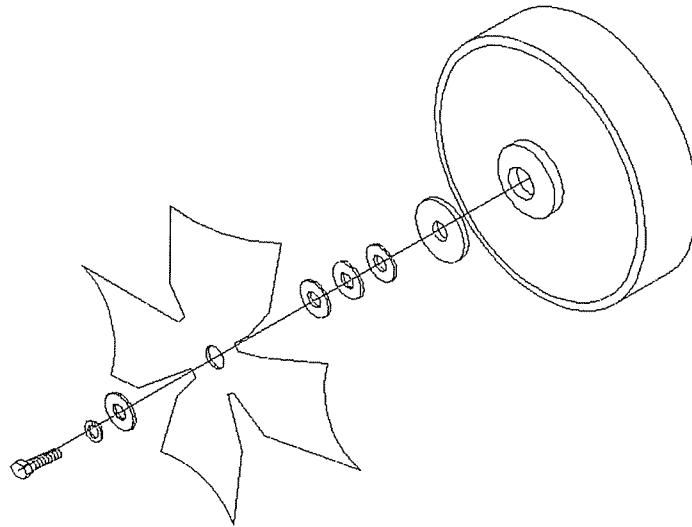

Tightening the Clutch Retaining Bolt:

1. Hold the Recoil cord to prevent shaft from turning.
2. Use the ½ inch socket to turn the bolt.
3. Tighten the bolt normally. **DO NOT OVER-TIGHTEN BOLT.** Over-tightening bolt can cause the bushing to flattening and seize to shaft.

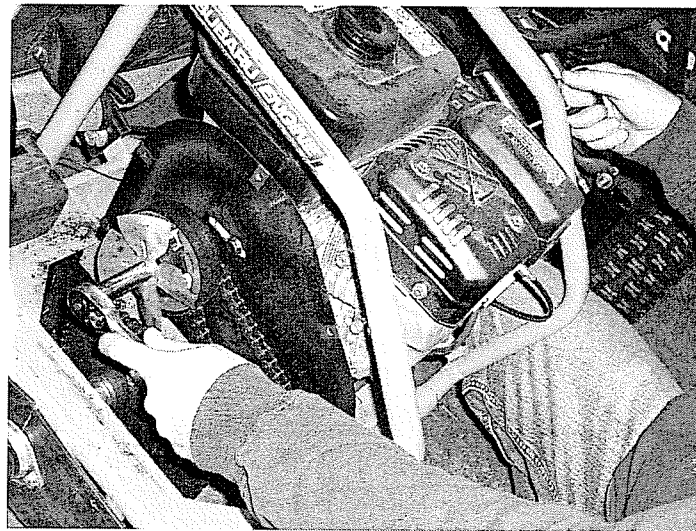

Replacing the Chain:

1. Align the chain on the sprockets.
2. Using needle nose pliers, secure the chain on the sprockets by reconnecting the master link/ clip to the chain.

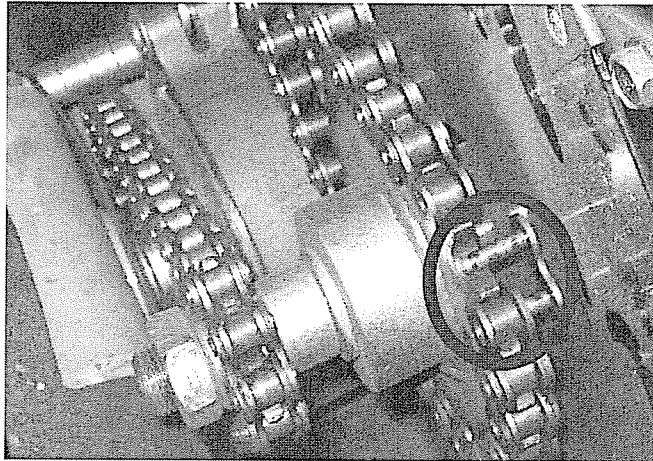

Tensioning the Chain:

1. Slide the engine towards the front of the Kart and the jackshaft towards the rear of the kart until there is approximately 3/8 inch to 1/2 inch of play in the chains.
2. Once proper tensioning is achieved, tighten (4) nuts that hold the engine mount bolts in place, using a 1/2 inch wrench.

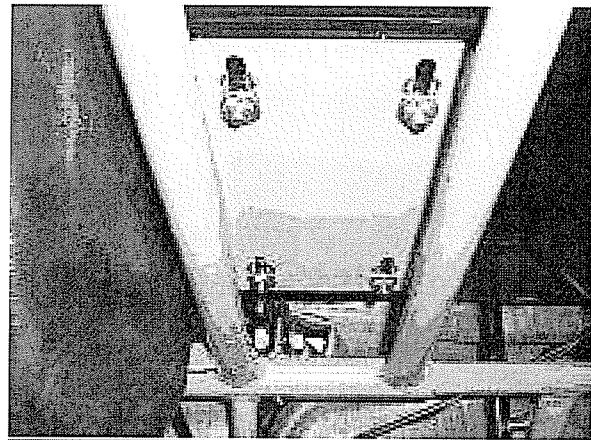
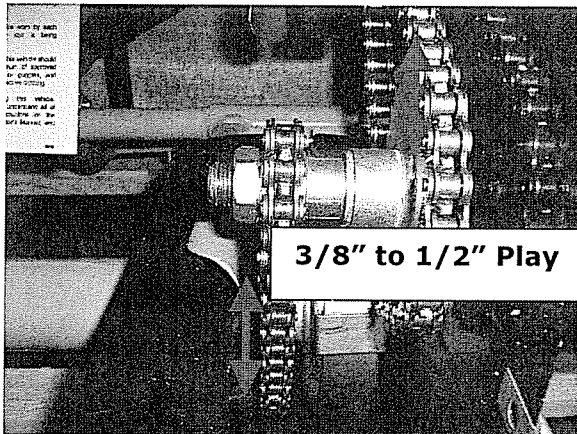

Re-installing the Plastic Cover:

1. Align Plastic Cover with bolt holes in Engine Guard.
2. Install and tighten (5) five bolts that fasten the cover to the Engine Guard, using the 3/8 inch nut driver

