

Owner's / Operator's Manual

READ THIS MANUAL CAREFULLY
IT CONTAINS IMPORTANT SAFETY INFORMATION

7150

150cc Fun Kart



RECOMMENDED MINIMUM OPERATOR AGE: 12

**THIS VEHICLE IS FOR OFF-ROAD USE ONLY
THIS VEHICLE IS NOT DESIGNED FOR USE ON RENTAL TRACKS OR RACING**

BEFORE OPERATING THIS VEHICLE, THE OWNER AND EACH OPERATOR MUST UNDERSTAND THIS VEHICLE WAS NOT DESIGNED OR MANUFACTURED TO MEET SPECIFICATIONS FOR USE ON PUBLIC ROADS, STREETS, HIGHWAYS, AND THOROUGHFARES. THE OWNER AND EACH OPERATOR MUST READ AND UNDERSTAND ALL THE INSTRUCTIONS FOR PROPER ASSEMBLY AND SAFE OPERATION, AS WELL AS THE INSTRUCTIONS CONCERNING THE ENGINE AND ALL OTHER PORTIONS OF THE VEHICLE. CHILDREN MUST BE OF AGE 12 OR OLDER AND SUPERVISED BY AN ADULT AT ALL TIMES WHEN USING THIS FUN-KART.

MY VEHICLE IDENTIFICATION NUMBER

Record the VIN number and Model number of your Manco Fun Kart below for service and insurance records.
The VIN number is hard tagged on the kart frame just behind the drivers seat.

VIN: _____

Model: 7150L-__ __

MANCO POWERSPORTS LIMITED WARRANTY

Manco PowerSports (hereinafter referred to as "Manco") hereby warrants to the original purchaser that the frame components of new Manco recreational vehicles will be free from defects in material and workmanship. The period of warranty is thirty (30) days from date of purchase for the component parts (except as noted below), ninety (90) days from the date of purchase for the frame, and (1) year from the date of purchase for the engine. Manco, if notified of a defect in material or workmanship during the period of warranty, will repair or replace, at its option, defective parts at no charge, other than the reasonable cost for the transportation of the component(s). Manco will also agree to pay reasonable charges for labor, if necessary, to perform a warranty repair.

The original purchaser must operate the vehicle and maintain the vehicle in accordance with the instructions provided in the Operator's Manual, the supplements hereto, and labels affixed to the vehicle. Additionally, within the (10) days of the discovery of an alleged defect, the original purchaser must provide written notification to: Manco's Customer Service Department at 4404 Engle Ridge Drive, Fort Wayne, IN 46804

General Exclusions: This limited warranty does not cover component failure or damage caused by any of the following: abnormal strain or stress, neglect; abuse; improper assembly of components which were supplied in the factory sealed carton after the vehicle left Manco; improper maintenance, improper use of the vehicle, including, but not limited to racing, jumping, stunt driving, or any other uses prohibited by the Operator's Manual. Additionally, this warranty does not cover component failure or damage to vehicles which are leased or rented, or vehicles which are used at a concession track.

Specific Exclusions: This limited warranty does not apply to components, which are subject to normal wear and tear. These items include, but are not limited to, the tires, brakes, throttle, shift, and brake cables, drive belt, the torque converter system, chain, seat, lights, fasteners, decals, or cosmetic body panels.

MANCO MAKES NO OTHER WARRANTY OF ANY KIND, EXPRESSED OR IMPLIED. ALL WARRANTIES OF MERCHANTABILITY AND FITNESS FOR A PARTICULAR PURPOSE WHICH EXCEED THE OBLIGATIONS AND TIME LIMITATIONS SPECIFIED IN THE WARRANTY ABOVE ARE HEREBY DISCLAIMED BY MANCO AND EXCLUDED FROM THIS WARRANTY. ADDITIONALLY, THIS WARRANTY EXCLUDES ANY INCIDENTAL OR CONSEQUENTIAL DAMAGES, INCLUDING BUT NOT LIMITED TO LOSS OF USE. SOME STATES DO NOT ALLOW A MANUFACTURER TO EXCLUDE OR LIMIT INCIDENTAL OR CONSEQUENTIAL DAMAGES AND, THEREFORE, THE ABOVE EXCLUSION MAY NOT APPLY TO YOU.

SOME STATES DO NOT ALLOW LIMITATIONS ON HOW LONG AN IMPLIED WARRANTY WILL LAST, IT IS POSSIBLE THAT THE ABOVE LIMITATION MAY NOT APPLY TO YOU. THIS WARRANTY GIVES YOU SPECIFIC LEGAL RIGHTS, AND YOU MAY ALSO HAVE OTHER LEGAL RIGHTS, WHICH VARY, FROM STATE TO STATE.

TABLE OF CONTENTS

<u>SUBJECT</u>	<u>PAGE</u>
General Information and Safety	
Vehicle Records -----	1
Warranty Information -----	1
Table of Contents -----	2
Forward -----	3
Warnings and Cautions -----	3 - 9
Some Words About Safety -----	9 - 12
Are You Ready To Drive? -----	13 - 16
Safe Driving Precautions -----	16 - 18
Kart Operation	
Kart Operation -----	18 - 20
Kart Features and Locations -----	21
Kart Service	
Air Cleaner -----	22
Engine Lubrication -----	22 - 23
Spark Plug -----	23
Carburetor -----	23
General Cleaning -----	24
General Lubrication -----	24
Chain Lubrication and Adjustment -----	24
Front and Rear Shock Adjustment -----	25
Shifter Adjustment -----	25
Storage Instruction -----	25
General Maintenance	
Tire/Wheel Replacement -----	26
Front End Alignment -----	26 - 27
Speed Reduction Installation -----	27
Replacement Parts and Service -----	28
Specifications	
Dimensions -----	28
Engine -----	28
Capacities -----	29
Miscellaneous -----	29
Periodic Check and Service Table -----	29
Electrical Schematic -----	30
Parts Listings	
Engine -----	31 - 50
Frame -----	51 - 69

FORWARD



Congratulations on the purchase of your Manco Fun Kart. Before operating this vehicle, the owner and each operator must understand that this vehicle was not designed or manufactured to meet specifications for use on public roads, streets, highways and thoroughfares. The owner, operator(s) and passenger(s) must read and understand all the instructions for proper assembly and safe operation, as well as the instructions concerning the engine and all other portions of the vehicle as described and illustrated in this manual and on the included safety video. Children must be of the specified age or older and supervised by an adult at all times when using the fun kart.

Be sure to follow the recommended maintenance schedule and service your kart accordingly. Preventative maintenance is extremely important to the longevity of your kart. **NOTE: A new kart requires an engine break in period of 5 hours, whereby the engine oil MUST be changed (See SERVICE section page 23)**

Beginners are urged to seek instruction from a dealer or qualified instructor before and during the initial use of this kart. It is also recommended to practice in a large open area to become familiar with the operation of the kart.

We hope you will have a fun, safe experience with our products and thank you again for choosing a Manco Fun Machine.

CAUTIONS AND WARNINGS

-  This is the safety alert symbol. When you see this symbol on your machine or in this manual, be alert to the potential for personal injury.
-  Read and follow all instructions in this Owner's manual and any accompanying supplements before attempting to operate this Fun-Kart. Make sure to view the Operations and Safety video.

WARNING

Indicates a potential hazard that could result in severe personal injury or death

CAUTION

Indicates a potential hazard which may result in personal injury or damage to the Fun-Kart.

NOTE: Use of the word "NOTE" will alert you to key information or instructions.

IMPORTANT SAFETY INFORMATION

WARNING

Exhaust fumes are toxic.

- California Proposition 65 WARNING: Gasoline engine exhaust from this Fun-Kart contains chemicals known to the State of California to cause cancer, birth defects, or other reproductive harm. The engine exhaust contains carbon monoxide, which is a tasteless, odorless, poisonous gas.
- NEVER operate this Fun-Kart indoors or in an enclosed area without adequate ventilation

WARNING

This Fun-Kart may have been supplied to you completely assembled. To prevent injury or death read and follow the assembly instructions to make sure the Fun-Kart was assembled properly.

WARNING

Check tire pressure before each use.

- Prior to operating the vehicle check and adjust tire pressure to the proper operating pressure as indicated on the sidewall of each tire. A tire pressure gauge is required to obtain accurate readings.

WARNING

Fun-Kart modification or removal of original equipment or safety decals can render the Fun-Kart unsafe for operation.

WARNING

Safety decals must be replaced if they become unreadable or detached from the Fun-Kart.

- If decals are unreadable or missing, warning of potential hazards or safety requirements may be lacking.

WARNING

This Fun-Kart is not designed for use on rental tracks of any kind.

 **WARNING**

NEVER adjust, repair, or clean the Fun-kart while it is in motion.

 **WARNING**

The safe operation of this Fun-Kart is dependent upon the operator's ability to exercise proper judgment.

- Operator and passenger must not be too small or too large for controlled operation.
- Operator and passenger must be of sufficient age, understanding, mental capacity, and physical capacity to safely operate the Fun-Kart.
- Fun-Kart should only be operated after mature, supervised instruction and sufficient practice in an un-congested area.

 **WARNING**

Operator and any passengers **MUST** always wear a properly fitting motorcycle helmet approved by agencies such as the Department of Transportation (DOT), Safety Helmet Council of America (SHCA), or Snell Memorial Foundation (SNELL).

- Most accident fatalities are due to head injuries.
- Operator (and any passenger) should also wear face shields or goggles, boots, gloves and other appropriate protective clothing.

(See KART OPERATION)

 **WARNING**

Long hair, loose clothes, or jewelry can get caught in moving parts below and behind the seat or surrounding environment.

- Remove or tie back anything loose that can reach below and behind the seat before riding.

 **WARNING**

NEVER place hands, feet, or any body parts or clothing near the engine, wheels, chain, and other rotating parts of the Fun-Kart while riding or running the engine.

- Use caution in performing required maintenance on or near operating engine.
- Use caution after the engine has been running, since the engine and other drive components may be extremely hot.

 **WARNING**

STOP the engine if the Fun-Kart makes unusual noises or vibrations.

- Check the Fun-Kart for damage.
- Excessive noise or vibration is a sign of loose or worn parts.

 **WARNING**

Keep guards in place at all times.

- Prevent accidental contact by the operator or service personnel while the Fun-Kart is running.
- The guards over the brake, clutch or torque converter, axle and drive sprockets also help prevent mud and debris from coming in contact with those items.

 **WARNING**

Be sure the passenger restraint system (i.e. Seat Belt) is properly adjusted and fastened at all times during operation.

- If the passenger restraint system is not properly used by the operator and/or passengers, loss of control and possible personal injury and/or Fun-Kart damage can occur.

 **WARNING**

When there is no passenger in the Fun-Kart, the passenger seatbelt must be securely fastened within the Fun-kart.

- If the passenger restraint system is not properly used by the operator and/or passenger, loss of control and possible personal injury and/or Fun-Kart damage can occur.

 **WARNING**

All screws, nuts, and bolts must be properly tightened to make sure the Fun-Kart is in safe operating condition.

 **WARNING**

Prevailing-torque type locknuts must be replaced with new after the old locknuts have been removed.

- Replace with the same type of locknut to make sure they function properly. Refer to the maintenance section for more information on locknuts.

 **WARNING**

Keep the engine free of dirt and debris, especially in the throttle linkage area.

 **WARNING**

NEVER start the engine without the operator properly seated and the restraint system properly adjusted and secured.

 **WARNING**

NEVER start the engine without checking to see that the throttle control is in idle position.

 **WARNING**

NEVER tamper with, alter, or change the Fun-Kart's engine governor settings.

- The governor as set by the engine manufacturer, limits maximum engine speed and protects the engine from damage.
- Excessive engine speed is potentially dangerous to operator, passengers, bystanders, and engine.

 **WARNING**

Check fuel supply before each use.

- NEVER fill fuel tank while the engine is running or hot.
- DO NOT overfill tank.
- ALWAYS allow at least ½" of expansion space at the top of tank.
- There should not be any fuel in the filler neck.
- Replace cap tightly to prevent a fuel spillage fire hazard.

NOTE: Always use an original gas cap or OEM replacement.

- NEVER fill fuel tank while the Fun-Kart is inside a building.
- After filling the tank, move the Fun-Kart at least ten feet before attempting to start the engine.

 **WARNING**

ALWAYS use extreme caution when starting the engine.

- Hot engine, muffler, or drive components can burn on contact.

 **WARNING**

Wet, slippery, rough, or sloped terrain is potentially dangerous and may result in injury if proper caution is not observed.

- ALWAYS SLOW DOWN
- Operator must use mature judgment, skill, and experience to choose a speed suitable for terrain and riding conditions in protecting operator and any bystanders.
- Operator must use mature judgment, skill and experience in choosing suitable terrain for individual operational capabilities.

 **WARNING**

When turning on pavement, loose gravel, or similar surfaces, there is an increased risk in loss of control.

**** ALWAYS SLOW DOWN! ****

 **WARNING**

ALWAYS SLOW DOWN when turning.

- High-speed turning can cause loss of control and/or possible operator injury.
- Turning on a slope increases the risk of rollover.
- Practice operation is required to coordinate turning skill.
- Failure to operate this Fun-kart at a safe speed while turning can result in a strong possibility of severe personal injury.

 **WARNING**

Washing or operating the Fun-Kart in freezing temperatures can result in water freezing in the throttle cable conduit and/or on the throttle mechanism.

- This may result in the throttle sticking which can cause the engine to continue to run and result in loss of control.

 **WARNING**

Operating the Fun-Kart in conditions where water, mud, snow, dirt, sand, or other debris can get into the throttle cable conduit and/or on the throttle mechanism can cause binding of the cable and/or the throttle mechanism.

- This may result in the throttle sticking which can cause the engine to continue to run and result in loss of control.

 **WARNING**

Assembly, maintenance, and/or repair of this Fun-Kart should only be performed by designated dealers or authorized small engine centers (for engine repairs) so that no unsafe conditions or modifications are made.

 **WARNING**

Read and keep all supplied printed material.

- Supplements to this Operator's Manual contain updated information relative to your specific Fun-Kart model. It is important to keep all of these documents for reference.

 **WARNING**

When making repairs or adjustments to the Fun Kart, the spark plug wire **MUST be disconnected and kept away from the spark plug to prevent accidental starting.**

- When working on, around, or restarting engine, use extreme caution to avoid contact with the muffler, cylinder head or any potentially hot area on or around the engine.
- Ensure that all guards are in place prior to starting the engine.

 **CAUTION**

During Fun-Kart storage, keep it in a place where gasoline fumes will not reach and open flame, spark, or other source of ignition.

- For long-term storage, fuel tank should be drained in an open, cool area.
- Engine must be allowed to cool before storage in any enclosure.
- NEVER store the Fun-kart in close proximity to appliances such as hot water heaters or furnaces.

 **WARNING**

NEVER operate the Fun-Kart while under the influence of alcohol, drugs, or medication of any kind.

- Such operation is dangerous to yourself and/or others.

 **CAUTION**

Brush Bars assembled to this Fun-Kart are for decorative purpose and limited brush protection.

- Brush Bars were not designed for roll over or to restrict all brush or tree branches from protruding into operator/passenger compartment.

 **CAUTION**

If the Fun-Kart should start making unusual noise or vibrating abnormally, the engine should be stopped and the spark plug wire disconnected. The vehicle should then be checked for damage. Excessive noise or vibration is generally a warning of loose or worn parts.

SOME WORDS ABOUT SAFETY

The following pages present important information and recommendations to help you drive your Kart safely. Please read through these pages thoroughly and view the Kart Safety DVD that was included with your unit.

SAFETY LABELS

The following labels have been applied to your Fun Kart and should be considered as permanent parts of the vehicle. If a label should come off, become hard to read, or become damaged, contact your dealer or Manco PowerSports Customer Service department for warning label replacements.



ATTENTION

Prior to operating vehicle, check and adjust tire pressure to the proper operating pressure as indicated on the sidewall of each tire.

11330-D

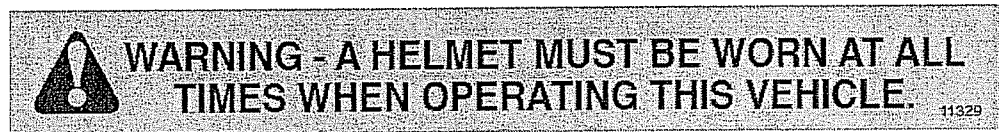
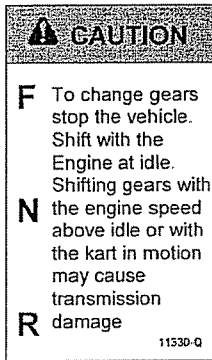

THIS KART IS NOT SUITABLE FOR A CHILD UNDER 12 YEARS
A Speed reduction kit is available for this kart.

11330-E

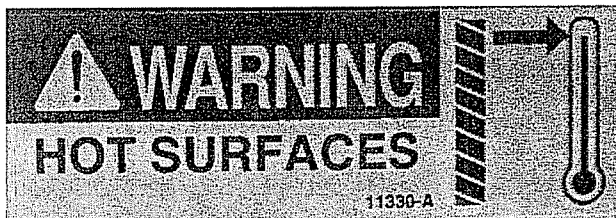
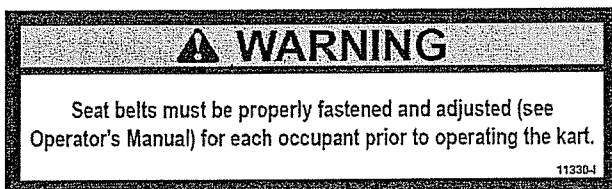
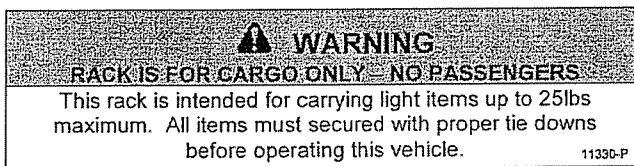

QUALIFICATIONS FOR FUN-KART USERS

This Fun-Kart is restricted to use by operator and passenger with a minimum age of twelve years. Fun-Karts are intended for use by operators who meet the physical and cognitive capabilities set out by the manufacturer in the material provided with the Fun-Kart. A 20mph speed reduction kit is available for this fun kart.

Consumer Responsibility for Safe Use and Maintenance of a Fun-Kart

1. Fun-Karts shall not be modified from the manufacturer's original design and configuration.
2. Fun-Karts shall not be used to perform racing, stunt riding, jumps, spinouts, donuts, or other maneuvers as they may cause loss of control. As such, these activities are likely to result in possible injury to the operator, bystanders, or both.
3. Prior to each use, the operator shall perform the preoperational checks specified by the manufacturer, and further verify:
 - a. Smooth throttle operation and positive return of the throttle linkage to a closed throttle position when released;
 - b. That the throttle cable and linkages operate properly and the throttle cable or other linkages be adjusted properly;
 - c. That the steering linkage is adjusted and operates smoothly;
 - d. That the engine stop switch is properly functioning;
 - e. That all guards originally supplied by the manufacturer are in proper place in serviceable condition;
 - f. That engine idle speed is below the point of clutch or torque converter engagement;
 - g. That the gas tank is in good condition and the proper gas cap is fastened securely;
 - h. That the braking system is functioning properly;
 - i. That all safety labels are in place, legible and understood;
 - j. That any and all axle guards, chain guards, torque converter covers, or other covers or guards supplied by the manufacturer are in place and in serviceable condition;
 - k. That tires are in good condition, inflated properly, and have sufficient tread remaining; and
 - l. That all fasteners are in place and tightened securely.
4. Fun-Kart engines shall not be started unless the operator is seated in proper position for vehicle operations and the brake fully engaged.
5. Long hair, loose clothes, or jewelry can get caught in moving parts below the seat or surrounding environment. Remove or tie back anything loose that can reach below or behind the seat before riding.
6. Fun-Karts shall only be fueled by a supervisor knowledgeable with regard to proper fueling techniques.
7. A supervisor shall verify personally that everyone operating or riding is knowledgeable, capable, and has the cognitive capacity to operate the Fun-kart safely, including those items specified in 1 through 6.
 - a. The supervisor shall only allow the use and operation of the Fun-Kart after demonstration that each operator can understand and operate all components of the Fun-Kart prior to use.
 - b. The supervisor shall provide continuous supervision during Fun-Kart use.
 - c. The supervisor shall not allow anyone to ride in or operate the Fun-Kart with long hair, loose clothes, or jewelry that can get caught in moving parts below the seat or surrounding environment. Remove or tie back anything loose that can reach below or behind the seat before riding.

8. Fun-Kart operators and passengers shall adhere to all manufacturer's recommendations and instructions, as well as comply with all laws and ordinances, as well as:
 - a. Operators shall stay seated with both hands on the steering wheel and both feet in the Fun-Kart at all times, whether moving or stationary, unless the Fun-Kart is stopped completely and the engine has been shut off.
 - b. Passengers shall remain seated with arms and legs inside the Fun-Kart at all times during Fun-Kart operation.
 - c. Shall observe minimum age restrictions.
 - d. Shall not ride the Fun-Kart if long hair, loose clothes, or jewelry reach below or behind the seat.

 **WARNING**

Long hair, loose clothes, or jewelry can get caught in moving parts below and behind the seat or surrounding environment. Remove or tie back anything loose that can reach below or behind the seat before riding.

- e. Shall not allow smoking in Fun-Kart.
 - f. Persons under the influence of drugs, alcohol, or intoxicants shall not supervise, operate, or ride in a Fun-Kart.
 - g. Fun-Karts shall operate only on a surface or terrain recommended by the Fun-Kart's manufacturer.
 - h. Fun-Karts shall not be operated on roads, streets, highways, or any other location where road vehicles are intended to travel.
 - i. Fun-Karts shall be operated only with adequate lighting and under conditions of suitable visibility.
9. Persons with the following conditions shall not ride in or operate a Fun-Kart:
 - a. Those with heart conditions
 - b. Pregnant women
 - c. Persons with head, back, or neck ailments, or prior surgeries to those areas of the body.
 - d. Persons with any mental or physical conditions, which may make them susceptible to injury or impair their physical dexterity or mental capabilities to recognize, understand, and perform all of the safety instructions, and be able to assume the hazards inherent in Fun-Kart use.
 10. Fun-Kart shall not be used to:
 - a. Transport a passenger except in the seating area provided.
 - b. Transport materials or equipment;
 - c. Transport animals.
 11. Fun-kart operators always shall use appropriate protective clothing, including but not limited to a motorcycle type helmet and eye protection, with appropriate certification, and any other equipment recommended by the Fun-Kart manufacturer including gloves, footwear, long sleeve shirts, and long pants.
 12. No operator or other person shall contact any portion of the engine, wheels, or drive train for any purpose including maintenance until the engine has been turned off and allowed to cool, and the Fun-Kart is in a stable and stationary position.
 13. Passenger restraints must be used in accordance with, and limited to, the manufacturer's guidelines.
 14. Fun-Kart components shall be maintained and repaired in accordance with the manufacturer's specifications and utilizing only the manufacturer's authorized replacement parts with installation performed by designated dealers or other skilled persons.

ARE YOU READY TO DRIVE?

Before each drive, you need to make sure that you and your kart are both ready to drive. To help get you prepared, this section discusses how to evaluate your driving readiness, what items you should check on your kart, and adjustments to make for your comfort, convenience, or safety. Before you drive your kart for the first time, we urge you to:

- Read this owner's manual and the labels on your kart carefully.
- Make sure you understand all the safety messages.
- Know how to operate all the controls.
- View and understand the included safety DVD

Protective Apparel

Although complete protection is not possible, wearing proper gear can reduce the chance of injury should you have an accident. The following suggestions will help you choose the proper protective gear.

Helmet and Eye Protection

Your helmet is your most important piece of protective gear because it offers the best protection against head injuries. A helmet should fit your head comfortably and securely.

Open-face helmets offer some protection, but a full-face helmet offers more. Regardless of the style, look for a D.O.T. (Department of Transportation) or Snell Memorial Foundation (SNELL) sticker on any helmet you buy. Always wear a face shield or goggles to protect your eyes and help your vision.

WARNING

Operating this kart without wearing an approved motorcycle helmet, eye protection, and protective clothing could increase your chances of head and/or eye injury, and the possibility of death in the event of a severe accident.

Always wear an approved motorcycle helmet that fits properly and wear eye protection (goggles or face shield), gloves, boots, long-sleeved shirt or jacket and long pants.

Additional Driving Gear

In addition to a helmet and eye protection, we also recommend:

- Sturdy off-road motorcycle boots to help protect feet, ankles, and lower legs.
- Off-Road motorcycle gloves to help protect your hands
- Driving pants with knee and hip pads, a driving jersey with padded elbows, and chest protection.

Driver Training

Developing your driving skills is an ongoing process. Even if you are an experienced driver, take time to become familiar with the kart controls and how the kart handles. Practice driving in a safe, open area to develop your skills. Do not drive on rough terrain until you get accustomed to the kart controls and feel comfortable with its size and weight.

 **WARNING**

Operating this kart without your seat belt could cause you to be thrown from the kart, causing serious injury or death.

No Alcohol or Drugs

Alcohol, drugs and karts don't mix. Even a small amount of alcohol can impair your ability to operate a kart safely. Likewise, drugs, even if prescribed by a physician, can be dangerous while operating a kart. Consult your doctor to be sure it is safe to operate a vehicle after taking medication.

 **WARNING**

Operating this kart after consuming alcohol or drugs can seriously affect your judgment, cause you to react more slowly, affect your balance and perception, and could result in serious injury or death. Never consume alcohol or drugs before or while operating this kart.

IS YOUR VEHICLE READY TO DRIVE?

Before each drive, it is important to inspect your kart and make sure any problems you find are corrected. A pre-drive inspection is a must, not only for safety, but because having a breakdown, or even a flat tire, can be a major inconvenience.

If your kart has overturned or has been involved in a collision, do not drive it until your kart has been inspected by your dealer. There may be damage or other problems that you cannot see.

 **WARNING**

Improperly maintaining this kart or failing to correct a problem before driving can cause an accident resulting in serious injury or death.

Always perform a pre-drive inspection before every drive and correct any problems.

Pre-Ride Inspection

The following checklist should be utilized to inspect your vehicle before each use to ensure that it is in proper working order.

ENGINE STOPPED CHECKLIST

	ITEM	INSPECTION PROCEDURE	ACTION
1.	Engine Oil Level	Add oil if required. Check for leaks. Tighten filler cap securely.	Refer to operator's manual.
2.	Fuel level	Add fuel if necessary. DO NOT overfill. DO NOT mix oil with gas. Replace cap tightly.	Refer to operator's manual. DO NOT refuel a hot engine. Allow engine to cool before adding fuel.
3.	Warning Decals	Make sure all warning decals are legible and securely attached.	Replace as necessary.
4.	Tires	Tread must have a minimum height of 1/8" at center of tire. Prior to operating vehicle, check and adjust tire pressure as indicated on the sidewall of each tire. A tire pressure gauge is required to obtain accurate readings.	Replace tires if tread height is less than 1/8" at center of tire. Add or remove air as necessary to meet requirements indicated on sidewall of each tire.
5.	Drive Train	Check condition and tension	Lubricate, adjust tension as necessary.
6.	Throttle	Check for smooth operation. Ensure throttle 'snaps' back to idle. Check for frayed or loose cable. Check for mud, debris, and ice in throttle mechanism	Replace damaged cable. Clean out any mud and debris. If ice is present, move Fun-kart to a warm place and allow the ice to melt and water to dry.
7.	Fasteners	Check wheels to see that all axle nuts are tightened securely. Check for missing fasteners. Check that all other fasteners are secure.	Tighten fasteners as necessary. Replace fasteners as necessary
8.	Brush bars	Make sure all brush bars are in place and securely attached.	Replace damaged bars or fasteners and tighten as necessary.
9	Steering	Make sure steering turns freely Check for proper 'toe-in' of wheels.	Lubricate and adjust as necessary.
10.	Frame / Chassis	Check for bent or otherwise damaged frame and/or other chassis components.	Replace as necessary.
11.	Battery	Check that the connections are tight and free of corrosion. Check that the battery is secured in place.	Clean / tighten as necessary.
12.	Guards	Check all guards covering moving parts.	Tighten fasteners on loose guards. Replace worn or damaged guards.

	ITEM	INSPECTION PROCEDURE	ACTION
13.	Lights	Check for proper operation	See OPERATION – Control Console
15.	Ball Joints	Check fasteners are tight, check that all cotter pins are in place. Check for ball looseness	See MAINTENANCE - Chassis

ENGINE STARTED CHECKLIST

	ITEM	INSPECTION PROCEDURE	ACTION
1.	Stop Switch	Perform stop switch test.	Repair / replace as necessary.
2.	Throttle	Check idle adjustment.	Adjust as necessary.
3.	Brakes	Ensure brakes function properly.	Adjust / replace as necessary.

Correct any discrepancies according to this Operator's Manual before riding. If the problem cannot be corrected, contact an authorized dealer for assistance or call 1-800-643-7332 for Customer Service.

SAFE DRIVING PRECAUTIONS

Off-Road Use Only: Your kart and its tires are designed and manufactured for off-road use only, not for use on paved surfaces. Driving on paved surfaces can affect the kart handling, control, and cause excessive wear to your tires.

WARNING

Operating this kart on paved surfaces may seriously affect handling and control of the kart, and may cause the vehicle to go out of control.

When driving off-road, also remember to always obey local off-road driving laws and regulations. Obtain permission to drive on private property. Avoid posted areas and obey "NO TRESPASSING" signs.

You should never drive your kart on public streets, roads or highways, even if they are not paved. Drivers of street vehicles may have difficulty seeing and avoiding you, which could lead to a collision.

WARNING

Operating this kart on public streets, roads or highways could result in a collision with another vehicle. Never operate this kart on any public streets, roads or highways, whether they are dirt, gravel or paved surfaces.

Keep Hands and Feet on Controls

When driving your kart, always keep both hands on the steering wheel and both feet on the foot controls. It is important to remain alert and remain focused when driving the kart. Removing hands or feet away from the controls can reduce your ability to react and maintain control of the kart.

WARNING

Removing your hands from the steering wheel or feet from the foot controls during operation can reduce your ability to control the kart and could result in a collision. Always keep both hands on the steering wheel and both feet on the foot controls of your kart during operation.

Control Speed

Driving at excessive speeds increases the likelihood of an accident. In choosing an appropriate speed, you must consider the capability of your kart, the terrain, visibility and other operating conditions, in addition to the skill and experience of the driver.

WARNING

Operating this kart at excessive speeds increases your chances of losing control of the kart, resulting in an accident. Always drive at a speed that is appropriate for your skill, your kart, the terrain, visibility and other operating conditions.

Use of this Kart on Unfamiliar or Rough Terrain

Before driving in an unfamiliar area, always check the terrain thoroughly. Don't drive fast on unfamiliar terrain or when visibility is limited (it is often difficult to react to hidden obstructions like rocks, bumps, or holes).

WARNING

Failure to use extra care when operating this kart on unfamiliar terrain could result in the kart overturning or going out of control. Go slowly and use extreme caution when operating on unfamiliar terrain. Always be alert to changing terrain conditions when operating the kart.

Never drive past the limit of visibility. Maintain a safe distance between your kart and other off-road vehicles. Always exercise caution and use extreme care on rough, slippery and loose terrain.

WARNING

Failure to use extra care when operating on excessively rough, slippery or loose terrain could cause loss of traction or vehicle control, resulting in an accident or overturn. Do not operate on excessively rough, slippery or loose terrain until you have learned and practiced the skills necessary to control the kart on such terrain. Always be especially cautious on these types of terrain.

Do Not Perform Stunts

You should always operate your kart in a safe and reasonable manner. When driving, always keep all four wheels on the ground.

WARNING

Attempting wheelies, jumps, and other stunts increase the chances of an accident, including an overturn. Never attempt stunt riding of any type and ride responsibly. Don't try to show off.

KART OPERATION

Operation controls

WARNING

Do not attempt to start or operate the engine until completely familiar with the location and use of each control necessary to operate this vehicle. The operator must know how to stop this machine before starting and driving it.

A. Throttle

The right foot pedal is the throttle, controlling the speed of the kart. As the engine speed increases above idle, the clutch automatically engages and moves the vehicle forward. To disengage the clutch at any time, allow the throttle to return to the idle position. (See Fig Below)

WARNING

Every time, prior to starting the engine, check the throttle assembly to ensure that when the pedal is pushed all the way forward the assembly is working smoothly and returns to idle when released. Do not operate this unit if pedal or engine throttle linkage fail to return to the idle position. If unable to correct the problem through lubrication, adjustment or replacement of worn parts, contact your dealer for assistance.

B. Brake

The brake is controlled by the left foot pedal (See Figure). Applying pressure to the pedal draws the brake pads against the brake disc at the wheels and slows or stops the kart.

Your kart is also equipped with a cable operated parking brake feature. To apply the brake, simply pull back on the parking brake lever and lock it into position.

D. Lights

This kart is equipped with both front running lights and a rear running/brake lamp. To turn the lights on, flip the switch

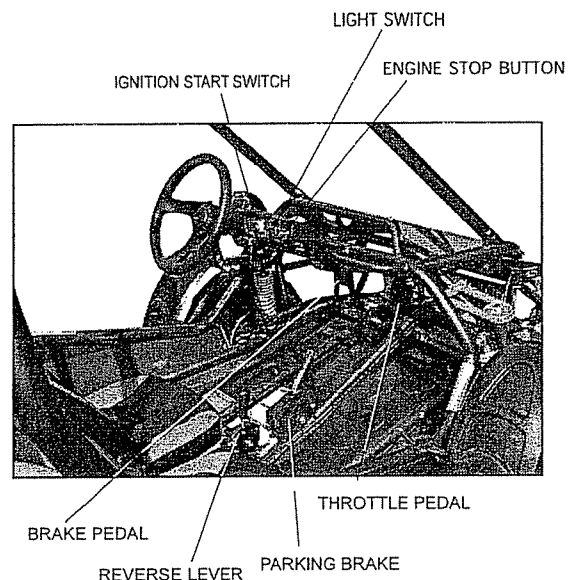

located next to the ignition switch on the dashboard of the unit. The rear brake light will activate automatically when the brake pedal is depressed.

 **WARNING**

The lights on this unit are designed for daytime use only and are intended to increase the visual awareness of this vehicle during daytime use. The lights are not intended for nighttime operation of the kart.

E. Engine Starting

With the unit shifted into the "NEUTRAL" gear, and with the parking brake applied, insert the key into key-switch. Turn the key clockwise, and release the key when the engine starts. **NOTE: Your Fun-Kart is equipped with (2) engine stop switches, one located on the dash and one located on the engine electrical cover. BOTH switches must be in the "RUN" position for the engine to start.** The engine will warm up within 5 minutes and the choke will close automatically allowing the engine to operate at the normal RPM (**Warning: Don't crank starter more than 5 seconds at one time**).

 **CAUTION**

This unit has been shipped with a special BREAK-IN oil pre-filled in the engine crankcase. This oil **MUST** be changed after 5 hours of operation. Replace with a 10W40 weight motor oil as described in the *SERVICE* section of this manual.

F. Engine Stop Switch

Before driving this vehicle, test the Engine Stop Switch to ensure that it is operating properly. With the engine running, push the Engine Stop Switch to the depressed position to shut down the engine.

NOTE: The key switch should always be turned to the "OFF" position when the kart is not in use to prevent draining the battery.

G. Rear View Mirror

The unit is equipped with a rear view mirror. Adjust the mirror such that objects can be easily seen while sitting in correct driving position.

H. Seat Adjustment

The unit is equipped with an adjustable drivers seat. To adjust, lift the lever just in front of the seat bottom (between the drivers legs) and move the seat either forward or backward. Release the lever at the desired seat location, ensuring that the lever snaps back into place to lock the seat.

 **WARNING**

Never operate this kart when the seat is not securely locked into position. Serious injury or death could occur due to loss of control. Always make seat adjustments with the kart fully stopped and the engine shut off.

I. Occupant Restraints

This kart is equipped with 3 point retracting seat belts. Insert the metal tongue into the buckle until it is securely attached. Final adjustments should be made with the plastic tension stop such that the belt is against the shoulder and chest with no excess slack. This kart is also equipped with a passenger grab bar located on the dash directly in front of the passenger seat.

J. Rear Cargo Rack

This kart is equipped with a rear cargo rack. The rack should be used for transporting small items, however, the items **MUST** be securely tied down with adequate straps or cords. Additionally, never exceed the rated load of 25lbs.

WARNING

Failure to properly tie down loose items and exceeding the maximum rating of the cargo rack may cause serious injury or death.

K. Gear Selection

This kart is equipped with a Drive / Neutral / Reverse transmission. To shift gears, bring the kart to a complete stop and let the engine RPM drop to the idle level. Move the shift lever to the desired gear and gently depress the throttle pedal.

CAUTION

Damage to the fun kart will occur if the unit is shifted into a different gear while the kart is still in motion. **ALWAYS** bring the kart to a complete stop before selecting a different gear.

L. Steering Adjustment

This kart is equipped with an adjustable tilt steering feature. To adjust, loosen the adjusting knob (A) until the steering column can move up and down. Select the appropriate setting and re-tighten the adjusting knob.

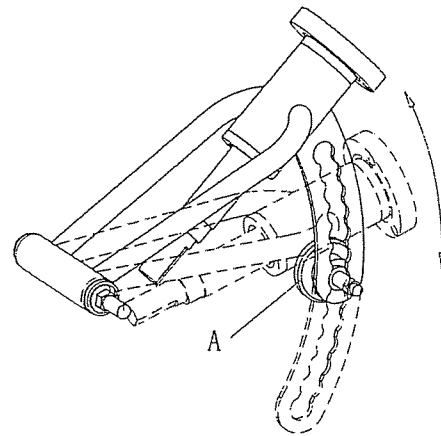

Steering Adjustment

WARNING

Do not operate the kart without ensuring that the steering adjustment knob is securely tightened. Serious injury or death could occur due to loss of control or rollover.

KART FEATURES AND LOCATIONS

